

Inhalt
Contents
Contenu

Inhoud
Contenido
Conteúdo

Contenuto
Содержание
目录

Einzelteilübersicht / Spare parts list / Liste des pièces détachées / Onderdelenoverzicht / Lista da piezas / Resumo de peça individual /
Singoli componenti / Отдельные детали / 零件概览 1

Montagetips / Tips for assembly / Tuyaux pour le montage / Montagetips / Consejos para el montaje / "Dicas" para montagem /
Consigli per il montaggio / Советы по сборке / 装配建议 2

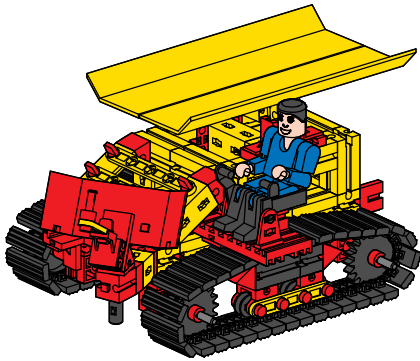

Radarfahrzeug / Radar vehicle / Véhicule à module radar / Radarvoertuig /
Vehículo de radar / Veículo radar / Veicolo radar / Машина с радаром /
雷达车 3

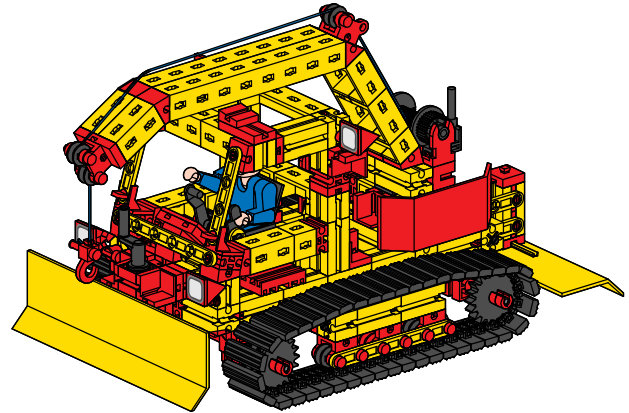

Pistenraupe / Snow groomer / Chenille de damage des pistes / Pistemaker /
Oruga de pistas / Lagarta de pista / Cingolato per pista / Гусеничная
снегоуплотнительная машина / 雪道整理机 8

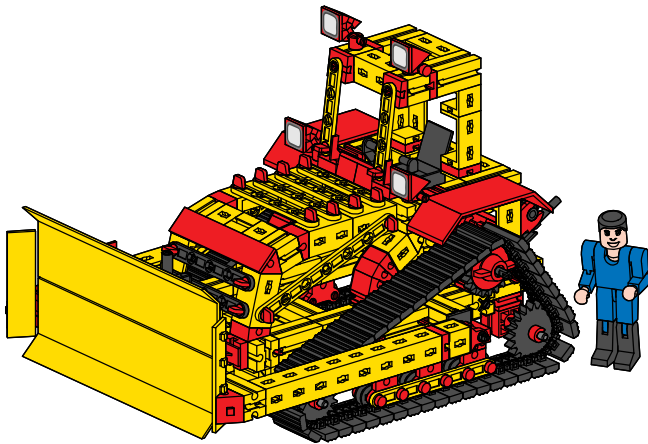

Bulldozer / Bulldozer / Bulldozer / Bulldozer / Niveladora de orugas /
Escavadeira / Bulldozer / Бульдозер / 推土机 19

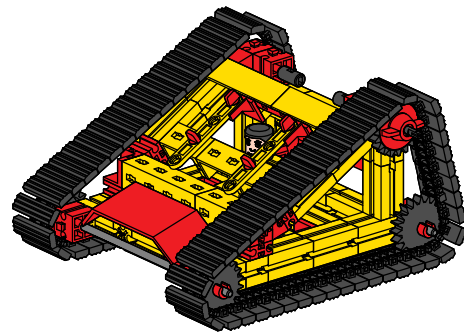

Allroader / Allroader / Véhicule tout terrain / Allroader / Todocamino /
Toda estrada / Allroad / Внедорожник / 四轮驱动履带 30

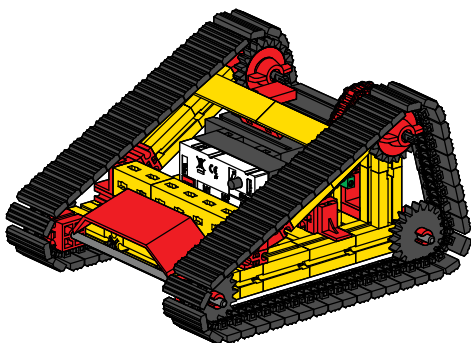













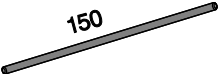











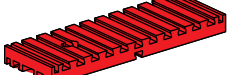

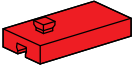







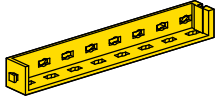
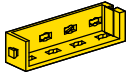



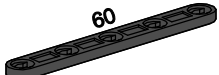



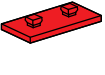

Allroader mit Motorisierung / Allroader with motorization / Véhicule tout
terrain avec motorisation / Allroader met motorisering / Todocamino con
motorización / Toda estrada com motorização / Allroad con motorizzazione /
Внедорожник с приводом / 带电机的四轮驱动履带 33



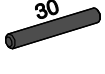

Einzelteilübersicht
Spare parts list
Liste des pièces détachées

Onderdelenoverzicht
Lista da piezas
Resumo de peça individual

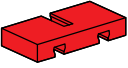

Singoli componenti
Отдельные детали
零件概览

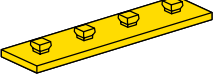
 60° 31 010 8 x	 30° 31 011 5 x	 31 021 2 x	 31 027 1 x	 150 31 030 2 x	 15° 31 981 9 x	 15° 31 982 75 x	 15° 31 983 5 x	 15° 31 994 2 x	 15° 31 997 1 x	 15° 31 998 1 x	 15° 31 999 1 x	 15° 32 064 9 x	 7.5° 32 071 4 x	 7.5° 32 085 8 x	 32 853 1 x	 60° 32 859 1 x	 60° 35 031 2 x	 60° 35 049 10 x	 60° 35 053 8 x	 60 35 065 2 x	 60 35 073 2 x	 60 35 088 1 x	 60° 35 973 1 x	 60 35 977 1 x	 60° 35 980 10 x	 60° 36 248 32 x	 60° 36 294 2 x	 60° 36 297 1 x	 60° 36 299 17 x	 60° 36 323 18 x	 60 36 819 3 x	 60 36 952 2 x	 60° 37 237 24 x	 60° 37 468 21 x	 60° 37 679 10 x	 60° 38 225 1 x	 60° 38 240 14 x	 60° 38 241 2 x	 60° 38 244 1 x	 60° 38 246 4 x	 60° 38 253 2 x	 60 38 258 15 x	 60° 38 260 2 x	 60 38 413 1 x	 60° 38 423 8 x
--	--	---	---	--	--	---	--	---	--	--	--	--	---	---	---	---	--	---	--	--	---	--	--	--	---	---	---	--	---	---	---	---	---	---	---	--	--	--	--	--	--	--	--	---	--





Einzelteilübersicht
Spare parts list
Liste des pièces détachées

	38 428 2 x
	38 446 1 x
	38 474 2 x
	38 531 2 x

Onderdelenoverzicht
Lista da piezas
Resumo de peça individual

	38 538 4 x
	38 540 4 x
	38 541 2 x
	38 545 3 x

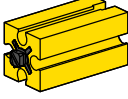
Singoli componenti
Отдельные детали
零件概览

	128 659 176 x		136 735 1 x
	130 593 2 x		
	136 528 37 x		
	136 529 14 x		

Montagetipps
Tips for assembly
Tuyaux pour le montage

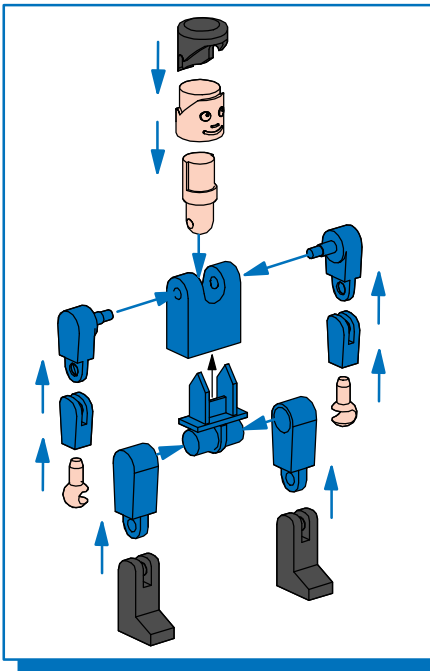

Montagetipps
Consejos para el montaje
"Dicas" para montagem

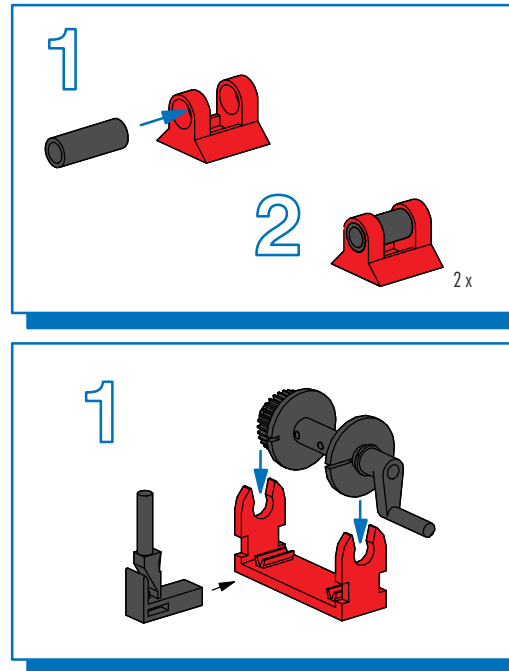

Consigli per il montaggio
Советы по сборке
装配建议

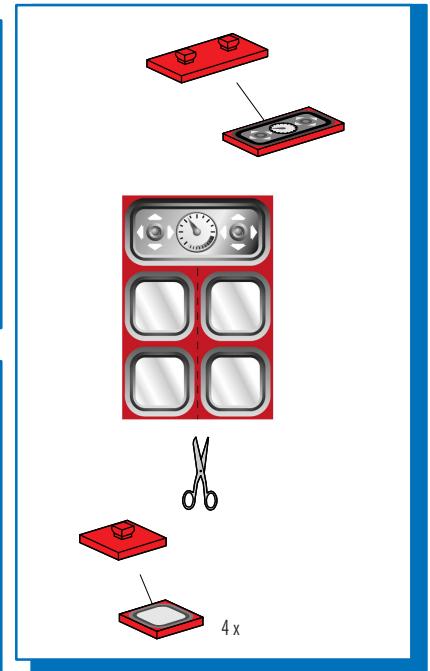

- Alle Einzelteile, insbesondere bewegliche Teile sind falls notwendig zu warten und zu reinigen.
- All components, especially moving parts, should be maintained and cleaned as necessary.
- Toutes les pièces détachées et en particulier les pièces mobiles, sont, si nécessaire, à entretenir et à nettoyer.
- Alle onderdelen, vooral de bewegende delen, kunnen, indien noodzakelijk, onderhouden en gereinigd worden.

- Achtung
Verletzungsgefahr an Bauteilen mit funktionsbedingten scharfen Kanten und Spitzen!
- Caution
Be careful not to hurt yourself on components with sharp or pointed edges!
- Attention
Risque de blessure sur les éléments comportant des arêtes et o pointes vives indispensables au bon fonctionnement!
- Let op
U kunt zich bezeren aan bouwstenen met sherpe randen of punten!

- Es necesario limpiar y mantener en buen estado todas las diferentes piezas - especialmente las piezas móviles.
- Caso necessário, todas as peças individuais, especialmente peças móveis, tem que ser submetidas à manutenção e ser limpidas.
- Se necessario, tutti i singoli componenti, soprattutto le parti mobili, si devono eventualmente sottoporre a manutenzione e pulizia.
- Все детали, особенно подвижные, требуют ухода и чистки.
- 必要时应保养和清洁所有零件，尤指运动部件。

- Attenzione
Esiste il pericolo di lesione con i pezzi di costruzione che hanno bordi e punte spigolosi necessari per la funzionalità del pezzo!
- Atenção
Perigo de ferimentos em peças componentes com cantos vivos e pontas obrigatórios para o funcionamento !
- Attention
Pericolo di lesioni dovute a componenti con spigoli vivi e punte per motivi funzionali!
- Будьте осторожны
Об острые края деталей и и наконечники можно обрезать!
- 注意
因功能需要而带有锋利的棱边和尖角的部件可能会带来受伤危险！